

PERFORMANCE DATA

PAVER (TIER 3)

BF 600 C-2



Greatest durability



Shorter set-up times



Exemplary efficiency

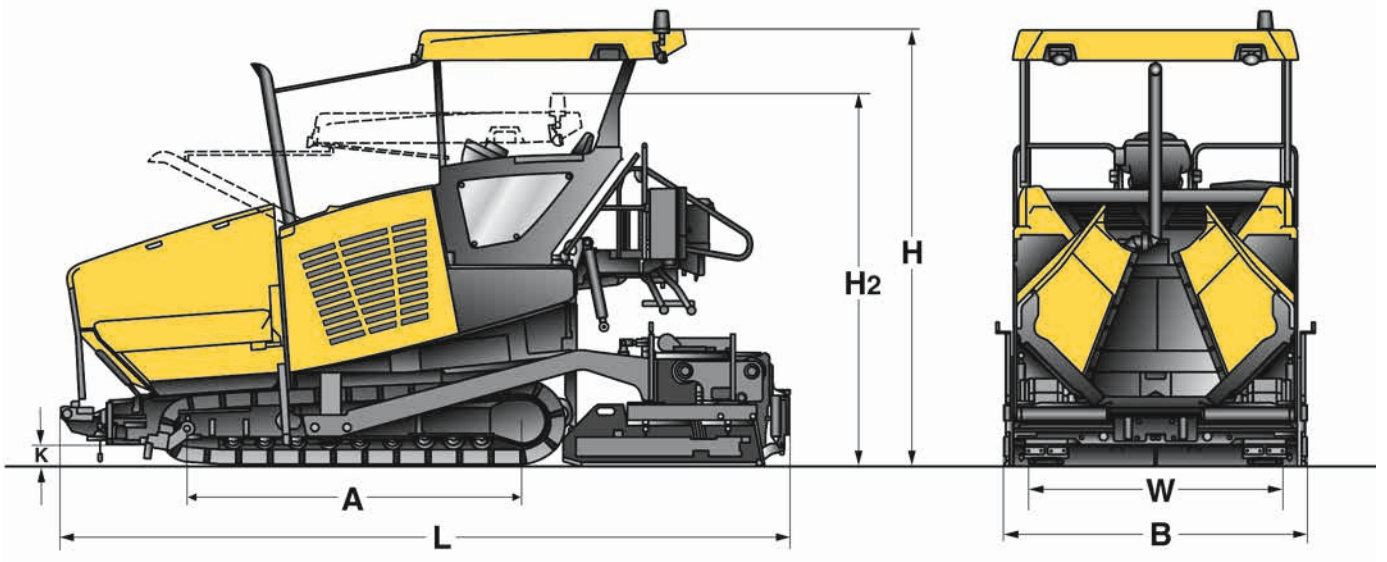

Dimensions in mm

	A	B	H	H₂	L	W
BF 600 C-2 S500	2975	2550	3910	3061	6360	2255
BF 600 C-2 S600	2975	3000	3910	3061	6360	2255



Save up to 17 % fuel – demand-driven hydraulics – with BOMAG ECOMODE.



Heats up nearly 60 % quicker – unique MAGMALIFE heating system.

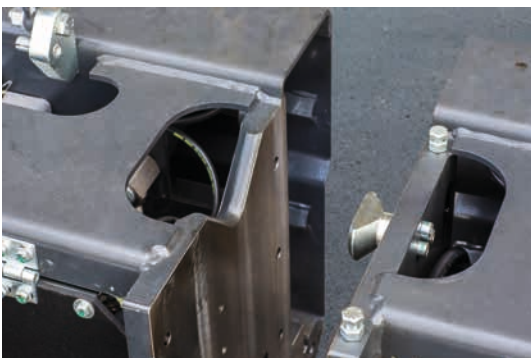

Attaching is up to 48 % quicker – thanks to the BOMAG QUICK COUPLING SYSTEM.



The right position in each situation – the comfortable driver's cabin.

Technical Data

BOMAG BF 600 C-2

Weight CECE

With S500 screed / with S600 screed kg 19500 / 19800

Dimensions

Transport length mm 6360
Transport width mm 2550 / 3000
Transport height mm 3061

Travel characteristics

Travel speed km/h 0-4
Working speed m/min⁻¹ 0-25 variable

Drive

Engine manufacturer DEUTZ
Type TCD 2012 L06
Emission stage Stage III a / TIER 3
Cooling liquid
Number of cylinders / Displacement cm³ 6 / 6067
Rated power kW / HP 116 / 158

Crawler assembly

Total length mm 2975
Width mm 300

Hopper

Capacity m³ 7,0
Width (wings open) mm 3330
Width (wings closed) mm 2270
Length mm 1800
Filling height (middle) mm 590

Conveyor

Number 2
Rotary speed U/min 64
Individual control Standard
Reversing operation Standard

Auger

Number mm 2
Auger diameter mm 350
Rotary speed U/min 117
Reversing operation Standard

Screed

S 500 / S 600
Basic width retracted mm 2500 / 3000
Basic width extended mm 5000 / 6000
Min. width with reduction skids mm 1800 / 2300
Mat thickness mm 300
Screed plate depth mm 400
Screed plate thickness mm 15
Heating electric
Crown % -2,5 ... +4,5
Tmaper frequency Hz 0-29
Vibration frequency Hz 20-58
Basic weight kg 3900 / 4200
Max. working width mm 8000

Filling capacities

Fuel l 285
Hydraulic oil l 160

Standard Equipment

Operator compartment

- SIDEVIEW
- Driver's seat: with swivel and side-shift
- Dashboard protection
- Hydraulic hinged roof
- Digital display for machine Management

Tractor

- ECOMODE
- Separate control of hopper wings
- Cleaning kit
- Hydraulic, height adjustable auger
- Track scraper
- 2 proportionally controlled and reversible wear-resistant cast augers; screw blades separately replaceable
- 2 independent and reversible scraper belts; high-wear resistant plates
- Rubber track pads

Screed

- L.C.S. Screed relief and traction increase system
- Screed temperature control
- MAGMALIFE Aluminium heating plates
- MAGMALIFE Automatic screed heating
- Hydraulic screed lock
- Crown adjustment
- Side control of auger/scraper belts

Other

- Tools
- 8 work lights
- 20/30 kVA generator
- Socket 2 x 240 volt

Optional Equipment

Operator compartment

- Hydraulic/electric movable SIDEVIEW platform
- Side windscreened platform
- Seat warmer
- Asphalt steam extraction

Tractor

- Central lubrication system
- Optional paint finish
- Biologically degradable hydraulic oil
- Hydraulic hopper front flap
- Hydraulic suspended and dampened push rollers

Screed

- Hydraulic crown adjustment
- Hinged side plates
- Heated side plates
- L.C.S. half-sided
- S 500 + S 600 extensions:
 - 250 mm
 - 500 mm
 - 750 mm
 - 1250 mm
- Reduction shoes
- Edge shaper 45°/60°

Levelling systems

- Height and cross-slope sensing by means of ultrasonic or mechanical sensors

Other

- Fleet management BOMAG TELEMATIC
- Moon-light balloon

